

- NOTES :-**
- ALL DIMENSIONS ARE IN MM.
 - DESIGN STANDARD BS EN 40-3-1&3
 - DESIGN CRITERIA :
 - BASIC WIND SPEED - 50 M/SEC.
 - DESIGN LIFE - 25 YEARS.
 - TERRAIN CATEGORY - 2
 - TOPOGRAPHY - FLAT
 - MATERIALS :
 - SHAFT : HOT ROLLED STEEL PLATE CONFORM TO BS EN 10025 OR EQUIVALENT GRADE.
 - FLANGE/GUSSETS/DOOR STIFFENER : AS PER BS EN 10025 OR EQUIVALENT GRADE.
 - FOUNDATION BOLTS : EN-8 GRADE
 - FINISHING : GALVANIZATION THICKNESS SHALL BE AVERAGE 70 MICRON.
 - TOLERANCES SHALL BE AS PER BS EN 40-2 UNLESS OTHERWISE SPECIFIED IN THE DRAWING
 - MAKE OF THE POLE "BAJAJ"
 - THIS HAS TO BE READ IN CONJUNCTION WITH FINAL OFFER.

- BAKELITE SHEET NOTES:-**
- 2.5 SQ.MM. CU FLEXIBLE WIRE WITH GREEN INSULATIONS SHALL BE USED FOR EARTHING.
 - WIRING & TERMINATION SHALL BE IN SCOPE OF ERECTION CONTRACTOR

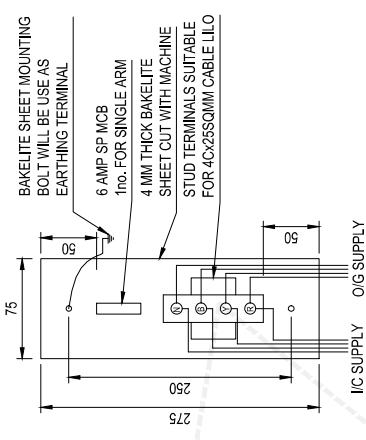

BAKELITE SHEET DETAIL



PLAN

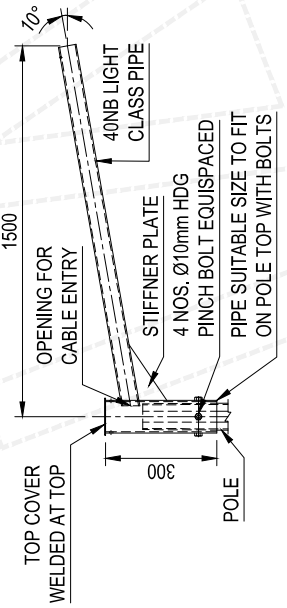

DETAIL FOR SINGLE ARM BRACKET

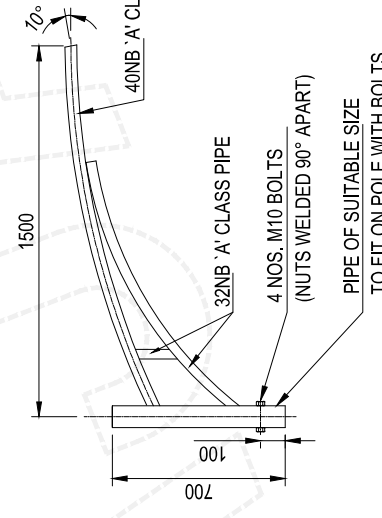

DETAIL FOR SINGLE ARM DECORATIVE BRACKET

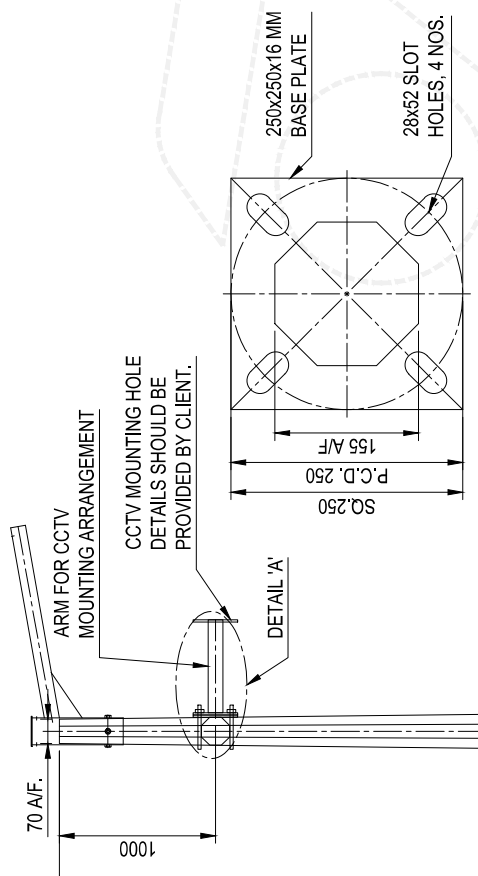

BASE PLATE DETAIL

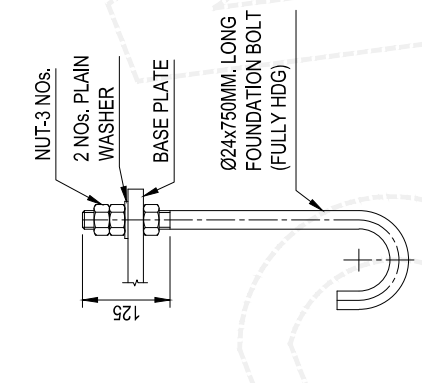

FOUNDATION BOLT DETAIL

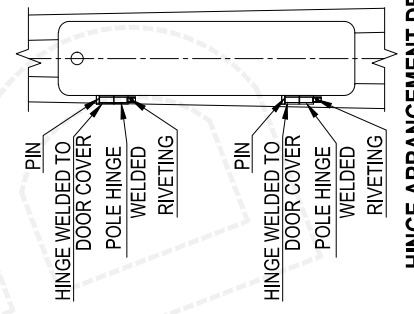

HINGE ARRANGEMENT DETAIL "Z"

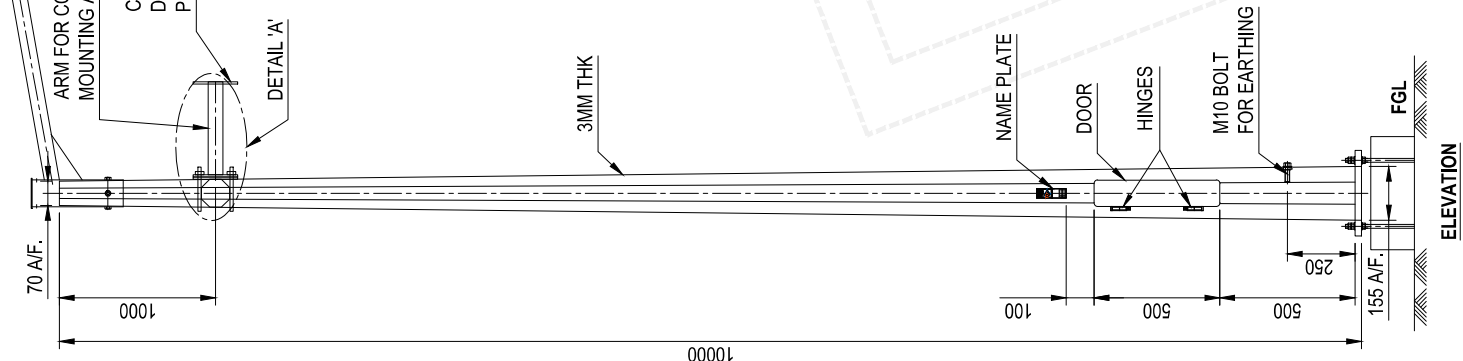

ELEVATION

TOLERANCES :-	
DIAMETERS A/F	± 2.5 %
POLE TOTAL LENGTH	± 1.2 %
POLE STRAIGHTNESS	± 0.3 %

DETAIL 'A'

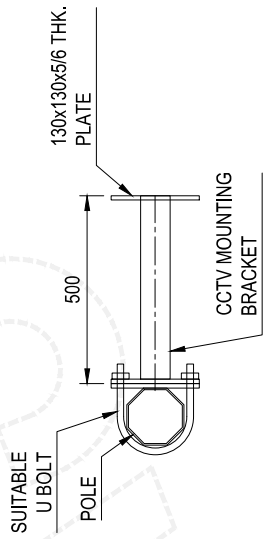

CLIENT	PLATEFORMES INDUSTRIELLES DU CONGO POINTE-NOIRE SAU
PROJECT	ZONE ECONOMIQUE SPECIALE DE POINTE-NOIRE
CONTRACTOR	*****
MANUFACTURER	BAJAJ
TITLE	INDICATIVE GENERAL ARRANGEMENT DRAWING OF 10M OCTAGONAL POLE WITH SINGLE ARM STANDARD & DECORATIVE BRACKET
DATE	17.10.2023
DRWN BY	MTP
DESIGNED BY	SK
CHECKED BY	KN
APPROVED BY	SA
PROJECT CODE	*****
DESIGN CODE	E57270
DRWN	CHK
APPRO	APPRO
REVISION DESCRIPTION	DRWN
DATE	APPRO
REV/NO	DATE
DRWN	CHK
APPRO	APPRO
PROJECT CODE	*****
DRG. NO.	EPC-SL-23-57270-OP-10M-GAD-001
SHT	01 OF 01
REV. NO.	00

This drawing is the property of BAJAJ ELECTRICALS LTD. & must be returned on request. It is submitted as confidential information in connection with enquiry, tenders, orders or contracts. It is not to be used for any other purpose or order nor may it be copied or lent without our authority in writing.